

Agilent Technologies, Inc.
1400 Fountaingrove Parkway
Santa Rosa, California 95403-1799



Model 437B
Service
File name 00437-90016

10

HP 437B POWER METER

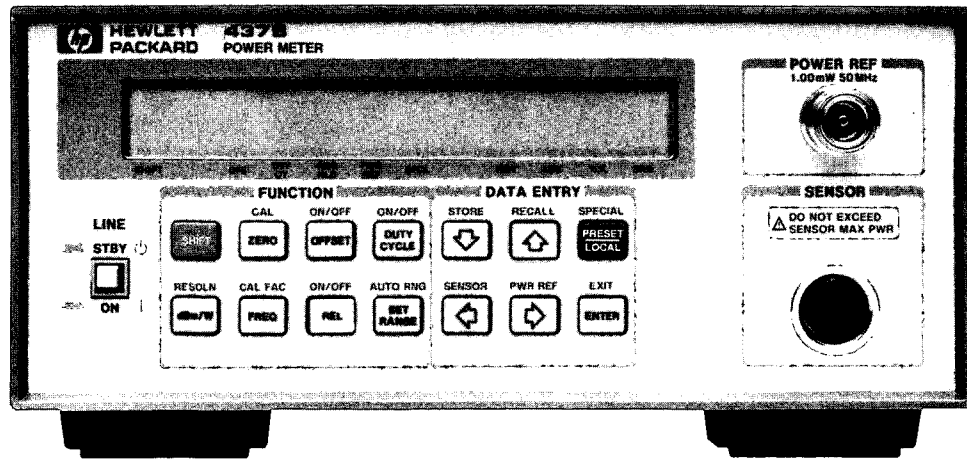

HP Part No. 00437-90016 E1088
 HP Binder Part No. 9282-1077



HP 437B POWER METER

SERIAL NUMBERS

This manual applies to instruments with serial numbers prefixed 2801A and above.

For additional important information about serial numbers, see INSTRUMENTS COVERED BY THIS MANUAL in Section 1.



**HEWLETT
PACKARD**

© Copyright HEWLETT-PACKARD COMPANY 1988
1501 PAGE MILL ROAD, PALO ALTO, CALIFORNIA, U.S.A.

SERVICE MANUAL PART NO. 00437-90016 E1088

Microfiche Service Manual Part No. 00437-90018

Operating Manual Part No. 00437-90015

Microfiche Operating Manual Part No. 00437-90017

Getting Started Guide Part No. 00437-90014

CERTIFICATION

Hewlett-Packard Company certifies that this product met its published specifications at the time of shipment from the factory. Hewlett-Packard further certifies that its calibration measurements are traceable to the United States National Bureau of Standards, to the extent allowed by the Bureau's calibration facility, and to the calibration facilities of other International Standards Organization members.

WARRANTY

This Hewlett-Packard instrument product is warranted against defects in material and workmanship for a period of one year from date of shipment. During the warranty period, Hewlett-Packard Company will, at its option, either repair or replace products which prove to be defective.

For warranty service or repair, this product must be returned to a service facility designated by HP. Buyer shall prepay shipping charges to HP and HP shall pay shipping charges to return the product to Buyer. However, Buyer shall pay all shipping charges, duties, and taxes for products returned to HP from another country.

HP warrants that its software and firmware designated by HP for use with an instrument will execute its programming instructions when properly installed on that instrument. HP does not warrant that the operation of the instrument, or software, or firmware will be uninterrupted or error free.

LIMITATION OF WARRANTY

The foregoing warranty shall not apply to defects resulting from improper or inadequate maintenance by Buyer, Buyer-supplied software or interfacing, unauthorized modification or misuse, operation outside of the environmental specifications for the product, or improper site preparation or maintenance.

NO OTHER WARRANTY IS EXPRESSED OR IMPLIED. HP SPECIFICALLY DISCLAIMS THE IMPLIED WARRANTIES OF MERCHANTABILITY AND FITNESS FOR A PARTICULAR PURPOSE.

EXCLUSIVE REMEDIES

THE REMEDIES PROVIDED HEREIN ARE BUYER'S SOLE AND EXCLUSIVE REMEDIES. HP SHALL NOT BE LIABLE FOR ANY DIRECT, INDIRECT, SPECIAL, INCIDENTAL, OR CONSEQUENTIAL DAMAGES, WHETHER BASED ON CONTRACT, TORT, OR ANY OTHER LEGAL THEORY.

ASSISTANCE

Product maintenance agreements and other customer assistance agreements are available for Hewlett-Packard products.

For any assistance, contact your nearest Hewlett-Packard Sales and Service Office. Addresses are provided at the back of this manual.

HP 437B

Herstellerbescheinigung

Hiermit wird bescheinigt, dass dieses Gerät/System in Übereinstimmung mit den Bestimmungen von Postverfügung 1046/84 funkenstört ist.

Der Deutschen Bundespost wurde das Inverkehrbringen dieses Gerätes/Systems angezeigt und die Berechtigung zur Überprüfung der Serie auf Einhaltung der Bestimmungen eingeräumt.

Zusatzinformation für Mess- und Testgeräte:

Werden Mess- und Testgeräte mit ungeschirmten Kabeln und/oder in offenen Messaufbauten verwendet, so ist vom Betreiber sicherzustellen, dass die Funk-Entstörbestimmungen unter Betriebsbedingungen an seiner Grundstücksgrenze eingehalten werden.

Manufacturer's Declaration

This is to certify that this product meets the radio frequency interference requirements of Directive FTZ 1046/1984. The German Bundespost has been notified that this equipment was put into circulation and has been granted the right to check the product type for compliance with these requirements.

Note: If test and measurement equipment is operated with unshielded cables and/or used for measurements on open set-ups, the user must ensure that under these operating conditions, the radio frequency interference limits are met at the border of his premises.

Safety Considerations

This product and related documentation must be reviewed for familiarization with safety markings and instructions before operation.

This product is a Safety Class I instrument (provided with a protective earth terminal).

Before Applying Power

Verify that the product is set to match the available line voltage and the correct fuse is installed.

Safety Earth Ground

An uninterruptable safety earth ground must be provided from the main power source to the product input wiring terminals, power cord, or supplied power cord set.

Warning



Any interruption of the protective (grounding) conductor (inside or outside the instrument) or disconnecting the protective earth terminal will cause a potential shock hazard that could result in personal injury. (Grounding one conductor of a two conductor outlet is not sufficient protection.) In addition, verify that a common ground exists between the unit under test and this instrument prior to energizing either unit.

Whenever it is likely that the protection has been impaired, the instrument must be made inoperative and be secured against any unintended operation.

If this instrument is to be energized via an autotransformer (for voltage reduction) make sure the common terminal is connected to neutral (that is, the grounded side of the mains supply).

Servicing instructions are for use by service-trained personnel only. To avoid dangerous electric shock, do not perform any servicing unless qualified to do so.

Adjustments described in the manual are performed with power supplied to the instrument while protective covers are removed. Energy available at many points may, if contacted, result in personal injury.

Capacitors inside the instrument may still be charged even if the instrument has been disconnected from its source of supply.

For continued protection against fire hazard, replace the line fuse(s) only with 250V fuse(s) of the same current rating and type (for example, normal blow, time delay, etc.). Do not use repaired fuses or short circuited fuseholders.

Safety Symbols



Instruction manual symbol: The product will be marked with this symbol when it is necessary for the user to refer to the instruction manual (see Table of Contents for page references).



Indicates hazardous voltages.



Indicates earth (ground) terminal.

Warning



The WARNING sign denotes a hazard. It calls attention to a procedure, practice, or the like, which, if not correctly performed or adhered to, could result in personal injury. Do not proceed beyond a WARNING sign until the indicated conditions are fully understood and met.

Caution



The CAUTION sign denotes a hazard. It calls attention to an operating procedure, practice, or the like, which, if not correctly performed or adhered to, could result in damage to or destruction of part or all of the product. Do not proceed beyond a CAUTION sign until the indicated conditions are fully understood and met.

5-1. Introduction

This section contains adjustments and checks that ensure proper performance of the Power Meter. Adjustments are not required on any fixed periodic basis, and normally are performed only after a performance test has indicated that some parameters are out of specification. Performance tests should be completed after any repairs that may have altered the characteristics of the instrument. The test results will make it possible to determine whether or not adjustments are required. Allow 30 minutes for the Power Meter to warm up, and then remove the top and bottom covers, for access to the test and adjustment points.

To determine which performance tests and adjustments to perform after a repair, refer to paragraph 5-5, Post-Repair Adjustments.

5-2. Safety Considerations

This section contains a warning that must be followed for your protection and to avoid damage to the equipment being used.

Warning



Adjustments described in this section are performed with power applied to the instrument and with protective covers removed. Maintenance should be performed only by trained personnel who are aware of the hazards involved. When the maintenance procedure can be performed without power, the power should be removed.

5-3. Equipment Required

Most of the adjustment procedures include a list of recommended test equipment. The test equipment is also identified on the test setup diagrams.

If substitutions must be made, the equipment used must meet the critical specification listed in Table 1-3 in Section 1.

5-4. Factory Selected Components

Factory selected components are identified on the schematics and parts lists by an asterisk(*) which follows the reference designator. The nominal value of the selected component is shown. Table 5-1 lists the reference designator, the service sheet where the component is shown, the value range, and the basis for selecting a particular value.

Note



Make adjustments only in the order specified.

5-5. Post-Repair Adjustments

Table 5-2 lists the adjustments related to repairs or replacement of any of the assemblies.

Table 5-1. Factory Selected Components

Reference Designator	Service Sheet	Range of Values	Basis of Selection
A4R73 A4VR3 combination	A4C	825 Ω with 5.11V Zener or 1470 Ω with 8.25V Zener	1. If the reference power is outside the range of 1.000 +/- 0.007 mW between 0C and 55C, and if the A4R73, A4VR3 combination is 825 Ω & 5.11V then change the A4R73, A4VR3 combination to 1470 Ω & 8.25V. However, if the A4R73, A41VR3 combination is already 1470 Ω & 8.25V, then a problem exists elsewhere.

Table 5-2. Post-Repair Adjustments, Tests, and Checks

Assembly Repaired	Related Adjustments or Performance Test	Reference Service Sheet
A1 Display	None	A3B
A2 Keyboard	None	A3B
A3 Central Processing Unit	4-7, 4-8	A3A-A3C
A4 Analog Assembly (Includes Ref Oscillator)	4-8, 4-9, 5-6, 5-7, 5-8, 5-9	A4A-A4C
50 MHz Reference Oscillator (Part of Analog Assembly)	4-10, 5-8, 5-9	A4C

5-6. 220 Hz Frequency Adjustment

Reference Service Sheet A4C

Description The 220 Hz is adjusted for maximum Power Meter readout.

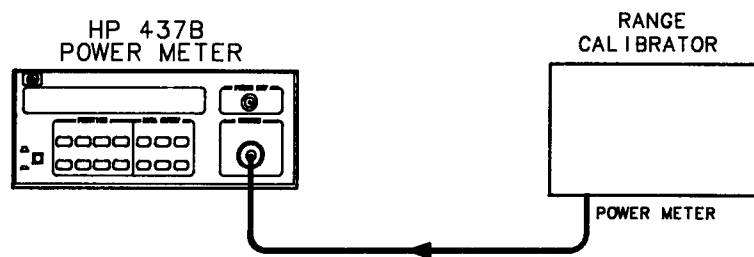

Figure 5-1. 220 Hz Frequency Adjustment Setup





Equipment Range Calibrator HP 11683A

Procedure

1. Turn on both the Power Meter and the range calibrator. Set the range calibrator controls as follows:

LINE ON
 RANGE 1 mW
 FUNCTION STANDBY
 POLARITY NORMAL

2. Connect the range calibrator to the Power Meter as shown in Figure 5-1.
3. Press the PRESET/LOCAL key, then the ENTER key.

4. Press the ZERO key on the Power Meter, and allow time (5 to 15 seconds) for the Power Meter zeroing routine to finish.
5. Set the range calibrator's FUNCTION switch to CALIBRATE.
6. Press the Power Meter's CAL (SHIFTed ZERO) key.
7. Using , , , or , modify the REF CF to read 100.0%.
8. Press the ENTER key.
9. Adjust A4R87 (FREQ) for the maximum front panel reading.

5-7. Ranges 4 and 5 Shaper Adjustment

Reference Service Sheet A4A

Description Ranges 4 and 5 Shaper circuits are adjusted for proper gain.

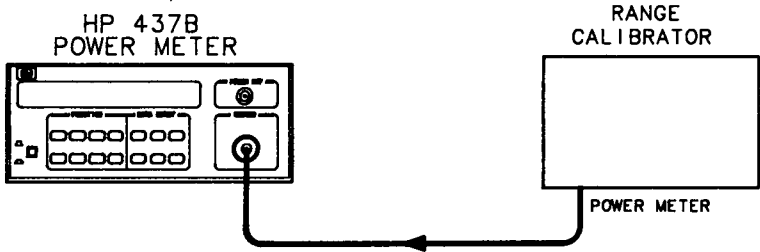

Figure 5-2. Ranges 4 and 5 shaper Adjustment Setup





Equipment Range Calibrator HP 11683A

Procedure

1. Connect range calibrator to the Power Meter as shown in Figure 5-2.
2. Set the range calibrator controls as follows:

LINE ON
 RANGE 1 mW
 FUNCTION STANDBY
 POLARITY NORMAL

3. Press the Power Meter's LINE switch to ON.

4. Press the PRESET/LOCAL key, then the ENTER key.
5. Press the ZERO key, and allow time (5-15 seconds) for the zeroing routine to finish.
6. Set the range calibrator's FUNCTION switch to CALIBRATE.
7. Press the Power Meter's CAL (SHIFTed ZERO) key.
8. Using , , , or , modify the REF CF to read 100.0%
9. Press the ENTER key.
10. Set the range calibrator's RANGE to 10 mW.
11. Adjust A4R111 (RNG 4 SHP) for a reading of 10.00 ± 0.01 mW on the Power Meter display.
12. Set the range calibrator's RANGE to 100 mW.
13. Adjust A4R112 (RNG 5 SHP) for a reading of 100.0 ± 0.1 mW on the Power Meter display.
14. Repeat steps 10 through 13 to check that interaction between steps has not caused a shift in settings.

5-8. Power Reference Frequency Oscillator Adjustment

Note



Adjustment of the Power Reference Oscillator frequency may also affect the output level of the oscillator. Thus, after the frequency is adjusted to 50.0 ± 0.5 MHz, the output level should be checked as described in Section 4. A procedure for adjusting the output to the specified level is provided in the next paragraph.

Reference

Service Sheet A4C

Description

Variable inductor A4L5 is adjusted to set the power reference oscillator output frequency to 50.0 ± 0.5 MHz.

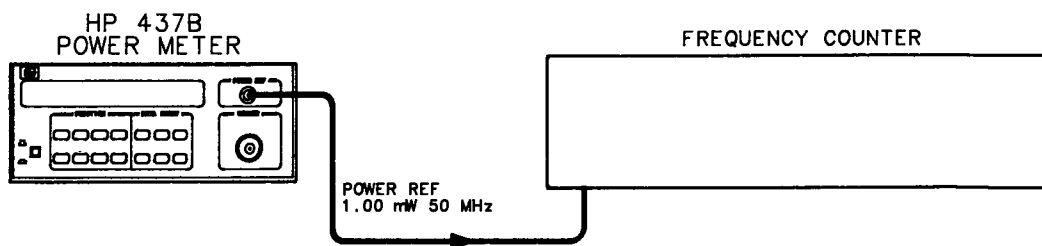



Figure 5-3. Power Reference Oscillator Frequency Adjustment Setup

Equipment

Frequency CounterHP 5328A Option 031

Procedure

1. Connect the equipment as shown in Figure 5-3. Set up the counter to measure frequency.
2. Set the Power Meter LINE switch to ON.
3. Press the PRESET/LOCAL key, then the ENTER key.
4. Press the PWR REF (SHIFTed ) key.
5. Observe the indication on the frequency counter. If it is 50.0 ± 0.5 MHz, no adjustment of the power reference oscillator frequency is necessary. If it is not within these limits, adjust the power reference oscillator frequency as described in steps 6 and 7.
6. Remove the Power Meter bottom cover.
7. Adjust A4L5 (FREQ) to obtain a 50.00 ± 0.5 MHz indication on the frequency counter.

5-9. Power Reference Oscillator Level Adjustment

Reference

Service Sheet A4C

Description

The power reference oscillator is factory-adjusted to 1.0 mW $\pm 0.7\%$ using a special measurement system accurate to 0.5% traceable to the National Bureau of Standards and allowing for a 0.2% transfer error. To ensure maximum accuracy in readjusting the power reference oscillator, the following procedure provides step-by-step instructions for using specified Hewlett-Packard instruments of known capability. If equivalent instruments are used, signal acquisition criteria may vary and reference should be made to the manufacturer's guidelines for operating the equipment.

Note



The Power Meter may be returned to the nearest HP office to have the power reference oscillator checked and/or adjusted. Refer to Section 2, PACKAGING.

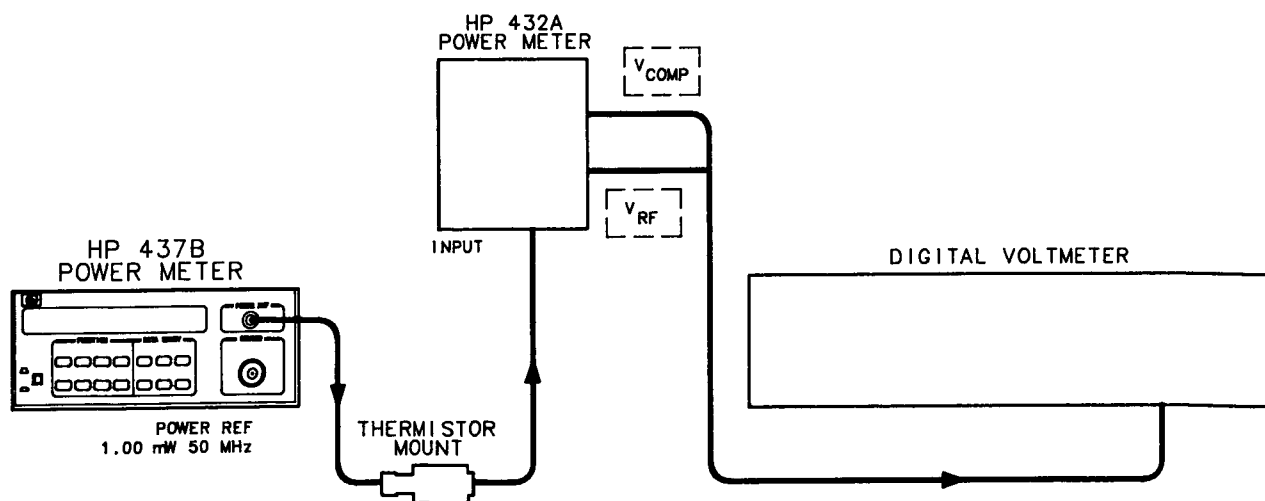

Figure 5-4. Power Reference Oscillator Level Adjustment Setup

Equipment

Test Power Meter..... HP 432A
 Thermistor Mount..... HP 478A-H75
 Digital Voltmeter (DVM)..... HP 3456A

Procedure

1. Set up the DVM to measure resistance. Connect the DVM between the Vrf connector on the rear panel of the test power meter and pin 1 on the thermistor mount end of the test power meter interconnect cable.
2. Round off the DVM indication to two decimal places and record this value as the internal bridge resistance (R) of the test power meter (approximately 200 ohms).

R (Internal Bridge Resistance) _____

3. Connect the test power meter to the Power Meter as shown in Figure 5-4.
4. Set the Power Meter LINE switch to ON. Ensure that the PWR REF is off. Wait thirty minutes for the test power meter thermistor mount to stabilize before proceeding to the next step.
5. Set the test power meter range switch to coarse zero and adjust the front panel coarse zero control to obtain a zero meter indication.
6. Fine zero the test power meter on the most sensitive range, then set the power meter range switch to 1 mW.

Note



Ensure that the DVM input leads are isolated from chassis ground when performing the next step.

7. Set up the DVM to measure microvolts.
8. Connect the positive and negative input leads, respectively, to the Vcomp and Vrf connectors on the rear panel of the test power meter.
9. Observe the indication on the DVM. If less than 400 microvolts, proceed with the next step. If 400 microvolts or greater, press and hold the test power meter fine zero switch and adjust the coarse zero control so that the DVM indicates 200 microvolts or less. Then release the fine zero switch and proceed to the next step.
10. Round off the DVM indication to the nearest microvolt and record this value as V0.

V0 _____

11. Disconnect the DVM negative input lead from the Vrf connector on the test power meter and reconnect it to chassis ground.
12. Press the PWR REF (SHIFTed ) key to turn the reference oscillator on.
13. Record the indication observed on the DVM as Vcomp.

Vcomp _____

14. Disconnect the DVM negative input lead from chassis ground and reconnect it to the Vrf connector on the rear panel of the test power meter. The DVM is now set up to measure V1 which represents the power reference oscillator output level.
15. Calculate the value of V1 equal to 1 mW from the following equation:

$$V_1 - V_0 = V_{\text{COMP}} - \sqrt{(V_{\text{COMP}})^2 - (10^{-3})(4R)(\text{EFFECTIVE EFFICIENCY})}$$

Where:

- V_0 = previously recorded value
- V_{COMP} = previously recorded value
- 10^{-3} = 1 milliwatt
- R = previously recorded value

EFFECTIVE EFFICIENCY = value for thermistor mount at 50 MHz
(traceable to the National Bureau of Standards).

16. Remove the Power Meter's top cover and adjust A4R114 (LEVEL) until the DVM indicates the calculated value of V1.

Typical Calculations

1. ACCURACY:

DVM Measurements:	(V_{COMP})	$\pm 0.018\%$
	$(V_1 - V_0)$	$\pm 0.023\%$
	(R)	$\pm 0.03\%$
Math Assumptions:		$\pm 0.01\%$
EFFECTIVE EFFICIENCY CAL (NBS):		$\pm 0.5\%$
MISMATCH UNCERTAINTY:		$\pm 0.1\%$
(Source and Mount SWR ≤ 1.05)		$\leq \pm 0.7\%$

2. MATH ASSUMPTIONS:

$$P_{\text{RF}} = \frac{2V_{\text{COMP}}(V_1 - V_0) + V_0^2 - V_1^2}{(4R)(\text{EFFECTIVE EFFICIENCY})}$$

$$\begin{aligned} \text{Assume: } V_0^2 - V_1^2 &= (V_1 - V_0)^2 \\ &- (V_1 - V_0)^2 = -V_1^2 + 2V_1 - V_0^2 \end{aligned}$$

$$\text{Want: } V_0^2 - V_1^2$$

$$\begin{aligned} \therefore \text{error} &= (V_1^2 + 2V_1V_0 - V_0^2) - (V_0^2 - V_1^2) \\ &= -2V_0^2 + 2V_1V_0 = 2V_0(V_1 - V_0) \end{aligned}$$

if $2V_0(V_1 - V_0) \ll 2V_{\text{COMP}}(V_1 - V_0)$ i.e., $V_0 \ll V_{\text{COMP}}$,
error is negligible.

$V_{\text{COMP}} \sim 4$ volts. If $V_0 < 400 \mu\text{V}$, error is $< 0.01\%$.
(Typically V_0 can be set to $< 50 \mu\text{V}$).

3. Derivation of Formula for $V_1 - V_0$

$$P_{\text{RF}} = \frac{2V_{\text{COMP}}(V_1 - V_0) + V_0^2 - V_1^2}{(4R)(\text{EFFECTIVE EFFICIENCY})}$$

$$\text{Desired } P_{\text{RF}} = 1 \text{ mW} = 10^{-3}$$

$$\therefore 10^{-3} = \frac{2V_{\text{COMP}}(V_1 - V_0) + V_0^2 - V_1^2}{(4R)(\text{EFFECTIVE EFFICIENCY})}$$

$$\text{Let } (4R)(\text{EFFECTIVE EFFICIENCY})(10^{-3}) = K$$

Substitute $-(V_1 - V_0)^2$ for $V_0^2 - V_1^2$ (see Math Assumptions under Accuracy).

$$\text{Then } 0 = (V_1 - V_0)^2 - 2V_{\text{COMP}}(V_1 - V_0) + K$$

$$\text{or } V_1 - V_0 = V_{\text{COMP}} - \sqrt{(V_{\text{COMP}})^2 - K}$$

8-1. General Information

This section contains information required for servicing the Power Meter. It includes block diagrams with theory and troubleshooting, schematic diagrams, and schematic diagram notes.

8-2. Service Sheets

The foldout pages in the last part of this section are called the service sheets (SS). They contain block diagrams, schematic diagrams, supplemental diagrams, and associated information.

8-3. Block Diagrams

The block diagram and related service information is found on Service Sheet BD1. BD1 is an overall block diagram that shows major functional sections of the Power Meter. It serves as an index to the more detailed information on the succeeding service sheets and is the starting point for most troubleshooting procedures.

8-4. Schematic Diagrams

Service Sheet 1 is a detailed block diagram and mechanical assembly drawing of the A1 Display Assembly and the A2 Keyboard Assembly. These assemblies are replaced as assemblies only, and SS1 is provided to show interconnects between these assemblies and the A3 Digital board. The schematic diagrams and their related information are presented in the additional seven Service Sheets A3a, A3b, A3c, A3d, and A4a, A4b, A4c. These diagrams, in functional groupings, are designed to aid in understanding the principles of operation and to aid in troubleshooting the Power Meter.

8-5. Safety Considerations

Before applying power, verify that the instrument is properly set to operate from the available line voltage and that the correct fuse is installed. An uninterrupted safety earth ground must be provided from the main power source to the instrument input wiring terminals, power cord, or supplied power cord set.

8-6. Warnings and Cautions

Pay attention to the WARNINGS and CAUTIONS. They must be followed for your protection and to avoid damage to the equipment.

Warning

Maintenance described herein must be performed with power supplied to the instrument and with the protective covers removed. Such maintenance should be performed only by service trained personnel who are aware of the hazards involved (for example, fire and electrical shock). Where maintenance can be performed without power applied, the power should be removed.

Any interruption of the protective (grounding) conductor (inside or outside of the instrument), or disconnection of the protective earth terminal will create a potential shock hazard and could result in personal injury. Grounding one conductor of a two-conductor outlet is not sufficient. Whenever it is likely that the protection has been impaired, the instrument must be made inoperative (i.e., secured against unintended operation).

If the instrument is to be energized via an autotransformer (for voltage reduction), make sure the common terminal is connected to neutral (that is, the grounded side of the mains supply).

Make sure that the 250 volt normal-blow fuses with the specified current rating are used for replacement. Do not use repaired fuses or short-circuited fuse holders. To do so could create a shock or fire hazard.

Caution

Some printed circuit boards contain devices that may be damaged if the board is removed or installed while the power is on. Verify that the LINE switch is OFF or that the power cord is unplugged before you remove or install a printed circuit board.

After removing devices from sockets, store the devices with the pins in conductive foam. This will prevent accidental damage from a static discharge.

8-7. Test Equipment, Tools, Aids, and Information

Test equipment and test accessories required to maintain the Power Meter are listed in Table 1-3, Recommended Test Equipment. Equipment other than that listed may be used if it meets the critical specifications listed.

8-8. Service Tools

Equipment recommended for use when changing components on printed circuit boards is listed in Table 8-1. The following unique service tools will make servicing of this instrument much easier.

Pozidriv Screwdrivers. Many screws in the Power Meter appear to be Phillips type, but they are not. To avoid damage to the screw heads, Pozidriv screwdrivers should be used. The Pozidriv No. 1 size can be ordered as HP part number 8710-0899, and the No. 2 size as HP part number 8710-0900.

Tuning Tools. For adjustments requiring non-metallic tuning tools, use the blade tuning tool HP part number 8710-0033 or hex tuning tool (JFD Model No. 5284) HP part number 8710-1010. For other adjustments, an ordinary screwdriver is sufficient. No matter which tool is used, never force any adjustment control against it stops. This is especially critical when adjusting variable inductors or capacitors.

8-9. Assembly Locations

Printed circuit board assemblies are numbered sequentially from front to back. For example, A1 is part of the front panel assembly.

8-10. Parts and Cable Locations

The locations of individual components on the printed circuit boards and other assemblies are shown adjacent to the schematic diagrams on the appropriate service sheets. The complete reference designator consists of the assembly designator plus the part designator. For example, A3R9 is resistor R9 on the A3 assembly. For specific component descriptions and ordering information, refer to Table 6-3, Replaceable Parts.

Mechanical parts have reference designators that begin with the letters MP. Mechanical parts such as screws, washers, and nuts are listed in the replaceable parts list.

The Power Meter has a mixture of Unified National (inch) and metric screws. The metric screws are defined by Industrial Fasteners publication (IFI 500) and are identified in the replaceable parts list as metric (M). Unified National screws have a dull steel gray appearance and the metric screws have a shiny silver appearance. Do not use a metric screw in a Unified National nut, thread damage will result.

8-11. Test Point and Adjustment Locations

Most test points and adjustments are indicated on individual circuit board assemblies. Test points and adjustments can also be found on the component locator diagrams adjacent to the assembly schematic diagrams.

8-12. Service Aids On Printed Circuit Boards

The service aids on the printed circuit boards include test points, indicator LEDs, reference designators, adjustment names, and assembly part numbers.

8-13. Other Service Documents

Service Notes, Change Pages, Application Notes and other service literature are available from Hewlett-Packard. For further information, contact your nearest Hewlett-Packard office.

Table 8-1. Etched Circuit Soldering Equipment

Item	Use	Specification	Item Recommended	HP P/N
Soldering Tip	Soldering, Unsoldering	*Shape: Chisel	*Ungar PL113	8690-0007
De-Solder Aid	To remove molten solder From connection	Suction Device	Soldapullt by Edson Co., Van Nuys, CA 91406	8690-0060
Rosin (flux) Solvent	To remove excess flux from soldered area before application of protective coating	Must not dissolve etched circuit base board	Freon	8500-0232
Solder	Component replacement; Circuit board repair wiring	Rosin (flux-core, high tin content (63/37 tin/lead) 18-gauge (AWG) 0.040 in. diameter preferred		8090-0607

*For working on circuit boards, for general purpose work, use No. 555 Handle (8690-0261) and No. 4037 heating unit 47.5--53.5 W (HP 8690-0006); temperature of 850 - 900 ° F; and Ungar No. PL113 1/8" chisel tip.

Table 8-2. Schematic Diagram Notes (1 of 8)

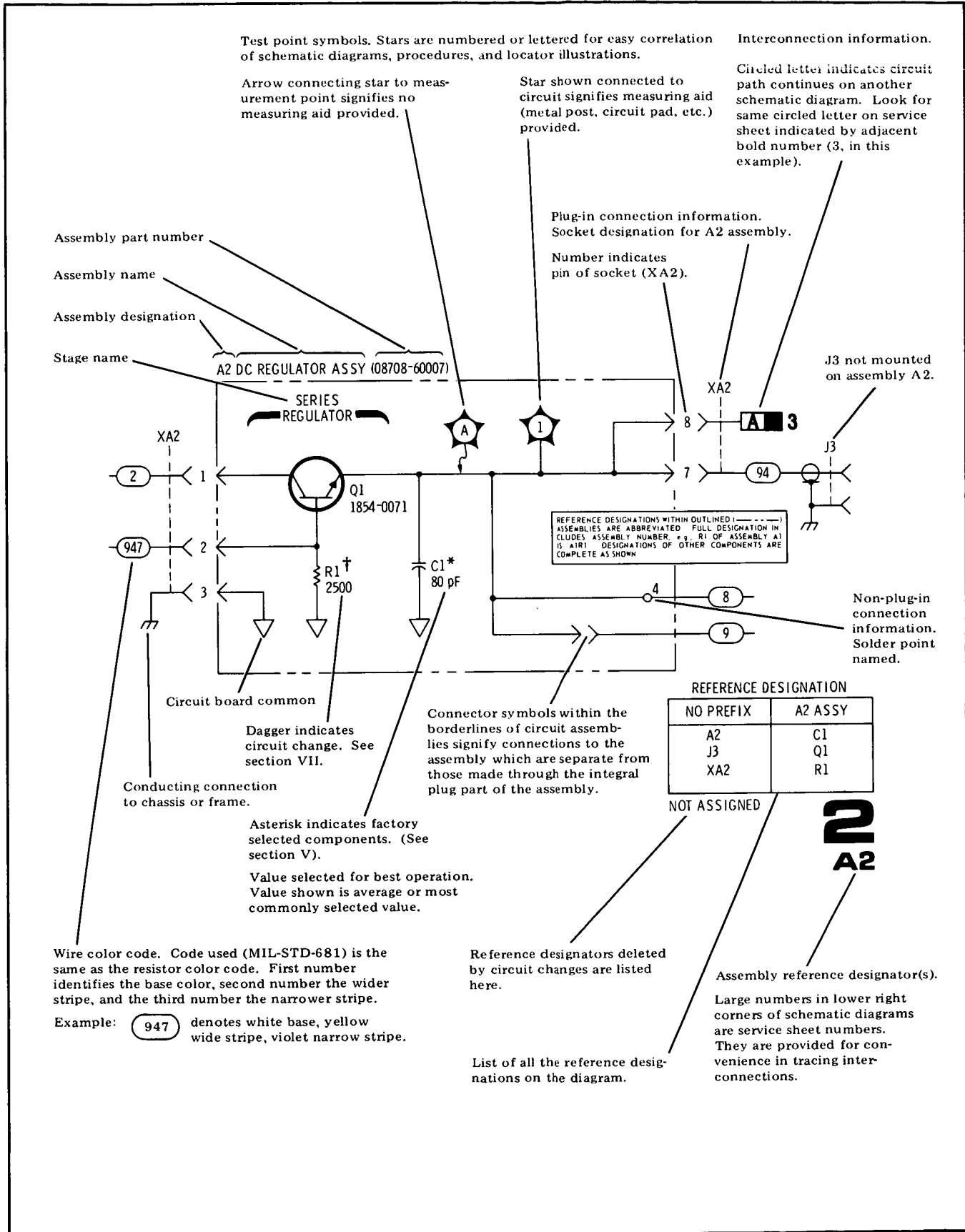

Table 8-2. Schematic Diagram Notes (2 of 8)

SCHEMATIC DIAGRAM NOTES













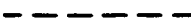

*	Asterisk denotes a factory-selected value. Value shown is typical.
†	Dagger indicates circuit change. See Section VII.
	Tool-aided adjustment.
	Manual control.
	Encloses front-panel designation.
	Encloses rear-panel designation.
	Circuit assembly borderline.
	Other assembly borderline.
	Heavy line with arrows indicates path and direction of main signal.
	Heavy dashed line with arrows indicates path and direction of main feedback.
	Indicates stripline (i.e., RF transmission line above ground).
	Wiper moves toward cw with clockwise rotation of control (as viewed from shaft or knob).
	Numbered Test Point measurement aid provided.
	Encloses wire or cable color code. Code used is the same as the resistor color code. First number identifies the base color, second number identifies the wider stripe, and the third number identifies the narrower stripe, e.g., denotes white base, yellow wide stripe, violet narrow stripe.
	A direct conducting connection to earth, or a conducting connection to a structure that has a similar function (e.g., the frame of an air, sea, or land vehicle).
	A conducting connection to a chassis or frame.
	Common connections. All like-designation points are connected.
	Letters = off-page connection, e.g., AKI Number = Service Sheet number for off-page connection, e.g., 12
	Number (only) = on-page connection.

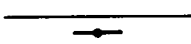
Table 8-2. Schematic Diagram Notes (3 of 8)

SCHEMATIC DIAGRAM NOTES



Indicates multiple paths represented by only one line. Letters or names identify individual paths. Numbers indicate number of paths represented by the line.

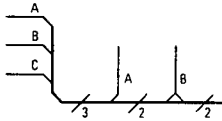
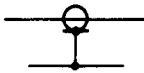

Coaxial or shielded cable.

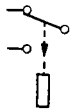

Relay. Contact moves in direction of arrow when energized.



Indicates a pushbutton switch with a momentary (ON) position.



Indicates a PIN diode.



Indicates a current regulation diode.



Indicates a voltage regulation diode.



Indicates a Schottky (hot-carrier) diode.

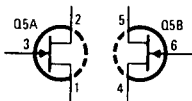

Multiple transistors in a single package—physical location of the pins is shown in package outline on schematic.



Identification of logic families as shown (in this case, ECL).

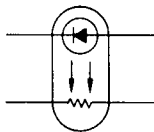

Indicates an opto-isolator of a LED and a photoresistor packaged together. The resistance of the photoresistor is a function of the current flowing through the LED.

Table 8-2. Schematic Diagram Notes (4 of 8)

DIGITAL SYMBOLOGY REFERENCE INFORMATION

Input and Output Indicators

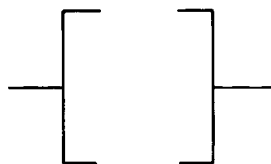

Implied Indicator—Absence of polarity indicator (see below) implies that the active state is a relative high voltage level. Absence of negation indicator (see below) implies that the active state is a relative high voltage level at the input or output.

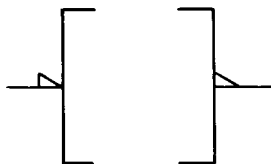

Polarity Indicator—The active state is a relatively low voltage level.

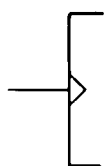

Dynamic Indicator—The active state is a transition from a relative low to a relative high voltage level.

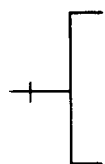

Inhibit Input—Input that, when active, inhibits (blocks) the active state outputs of a digital device.

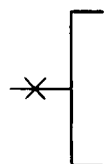

Analog Input—Input that is a continuous signal function (e.g., a sine wave).

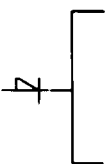

Polarity Indicator used with Inhibit Indicator—Indicates that the relatively low level signal inhibits (blocks) the active state outputs of a digital device.

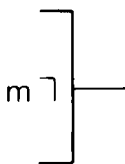

Output Delay—Binary output changes state only after the referenced input (m) returns to its inactive state (m should be replaced by appropriate dependency or function symbols).

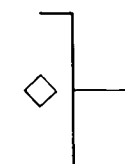

Open Collector Output—Output that must form part of a distributed connection.

Table 8-2. Schematic Diagram Notes (5 of 8)

DIGITAL SYMBOLOGY REFERENCE INFORMATION

Input and Output Indicators (Cont'd)

3-STATE Three-state Output—Indicates outputs that can have a high impedance (disconnect) state in addition to the normal binary logic states.

Combinational Logic Symbols and Functions

& AND—All inputs must be active for the output to be active.

≥ 1 OR—One or more inputs being active will cause the output to be active.

$\geq m$ Logic Threshold— m or more inputs being active will cause the output to be active (replace m with a number).

$= 1$ EXCLUSIVE OR—Output will be active when one (and only one) input is active.

$= m$ m and only m —Output will be active when m (and only m) inputs are active (replace m with a number).

= Logic Identity—Output will be active only when all or none of the inputs are active (i.e., when all inputs are identical, output will be active).

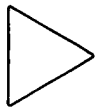

Amplifier—The output will be active only when the input is active (can be used with polarity or logic indicator at input or output to signify inversion).

X/Y

Signal Level Converter—Input level(s) are different than output level(s).



Bilateral Switch—Binary controlled switch which acts as an on/off switch to analog or binary signals flowing in both directions. Dependency notation should be used to indicate affecting/affected inputs and outputs. Note: amplifier symbol (with dependency notation) should be read to indicate unilateral switching.

X→Y

Coder—Input code (X) is converted to output code (Y) per weighted values or a table.

(Functional Labels)

The following labels are to be used as necessary to ensure rapid identification of device function.

MUX Multiplexer—The output is dependent only on the selected input.

DEMUX Demultiplexer—Only the selected output is a function of the input.

CPU Central Processing Unit

PIO Peripheral Input/Output

SMI Static Memory Interface

Table 8-2. Schematic Diagram Notes (6 of 8)

DIGITAL SYMBOLOGY REFERENCE INFORMATION

Sequential Logic Functions

1 

Monostable—Single shot multivibrator. Output becomes active when the input becomes active. Output remains active (even if the input becomes inactive) for a period of time that is characteristic of the device and/or circuit.

G 

Oscillator—The output is a uniform repetitive signal which alternates between the high and low state values. If an input is shown, then the output will be active if and only if the input is in the active state.

FF

Flip-Flop—Binary element with two stable states, set and reset. When the flip-flop is set, its outputs will be in their active states. When the flip-flop is reset, its outputs will be in their inactive states.

T

Toggle Input—When active, causes the flip-flop to change states.

S

Set Input—When active, causes the flip-flop to set.

R

Reset Input—When active, causes the flip-flop to reset.

J

J Input—Analogous to set input.

K

K Input—Analogous to reset input.

D

Data Input—Always enabled by another input (generally a C input—see Dependency Notation). When the D input is dependency-enabled, a high level at D will set the flip-flop; a low level will reset the flip-flop. Note: strictly speaking, D inputs have no active or inactive states—they are just enabled or disabled.

m

Count-Up Input—When active, increments the contents (count) of a counter by “m” counts (m is replaced with a number).

-m

Count-Down Input—When active, decrements the contents (count) of a counter by “m” counts (m is replaced with a number).

→ m

Shift Right (Down) Input—When active, causes the contents of a shift register to shift to the right or down “m” places (m is replaced with a number).

← m

Shift Left (Up) Input—When active, causes the contents of a shift register to shift to the left or up “m” places (m is replaced with a number).

NOTE

For the four functions shown above, if m is one, it is omitted.

(Functional Labels)

The following functional labels are to be used as necessary in symbol build-ups to ensure rapid identification of device function.

Table 8-2. Schematic Diagram Notes (7 of 8)

DIGITAL SYMBOLOGY REFERENCE INFORMATION

Sequential Logic Functions (Cont'd)

mCNTR	Counter—Array of flip-flops connected to form a counter with modulus m (m is replaced with a number that indicates the number of states: 5 CNTR, 10 CNTR, etc.).
REG	Register—Array of unconnected flip-flops that form a simple register or latch.
SREG	Shift Register—Array of flip-flops that form a register with internal connections that permit shifting the contents from flip-flop to flip-flop.
ROM	Read Only Memory—Addressable memory with read-out capability only.
RAM	Random Access Memory—Addressable memory with read-in and read-out capability.

Dependency Notation

mAm	Address Dependency—Binary affecting inputs of affected outputs. The m prefix is replaced with a number that differentiates between several address inputs, indicates dependency, or indicates demultiplexing and multiplexing of address inputs and outputs. The m suffix indicates the number of cells that can be addressed.
Gm	Gate (AND) Dependency—Binary affecting input with an AND relationship to those inputs or outputs labeled with the same identifier. The m is replaced with a number or letter (the identifier).
Cm	Control Dependency—Binary affecting input used where more than a simple AND relationship exists between the C input and the affected inputs and outputs (used only with D-type flip-flops).
Vm	OR Dependency—Binary affecting input with an OR relationship to those inputs or outputs labeled with the same identifier. The m is replaced with a number or the letter (the identifier).
Fm	Free Dependency—Binary affecting input acting as a connect switch when active and a disconnect when inactive. Used to control the 3-state behavior of a 3-state device.

NOTE

The identifier (m) is omitted if it is one—that is, when there is only one dependency relationship of that kind in a particular device. When this is done, the dependency indicator itself (G, C, F, or V) is used to prefix or suffix the affected (dependent) input or output.

Table 8-2. Schematic Diagram Notes (8 of 8)

DIGITAL SYMBOLOGY REFERENCE INFORMATION**Miscellaneous**

	Schmitt Trigger—Input characterized by hysteresis; one threshold for positive going signals and a second threshold for negative going signals.
Active	Active State—A binary physical or logical state that corresponds to the true state of an input, an output, or a function. The opposite of the inactive state.
Enable	<p>Enabled Condition—A logical state that occurs when dependency conditions are satisfied. Although not explicitly stated in the definitions listed above, functions are assumed to be enabled when their behavior is described. A convenient way to think of it is as follows:</p> <p>A function becomes active when:</p> <ul style="list-style-type: none">• it is enabled (dependency conditions—if any—are satisfied)• and its external stimulus (e.g., voltage level) enters the active state.

Service Sheet BD1 Overall Trouble- shooting

References

Troubleshooting Strategy	Section 8 (Front)
Internal Views	Pages 8-65 and 8-66
Replaceable Parts List	Section 6
Post-Repair Adjustments	Section 5

Principles of Operation

The HP 437B Power Meter is a programmable single-channel average responding power meter with a built in 1 mW 50 MHz power reference. For purposes of explanation and troubleshooting the Power Meter is split into three functional sections:

1. The Digital Section and display/keyboard.
2. The Analog Section.
3. The Power Supply.

The keyboard and display are not user repairable, but they can be replaced separately.

The Digital Section executes all functions that are enabled by the user via front panel keystrokes (local operation) or HP-IB commands (remote operation). The overall power range and frequency response of the Power Meter is determined by the power sensor that is connected to the front panel input connector.

The power sensor converts the input power to an analog voltage. This voltage is conditioned and digitized by the Analog Section. The Digital Section calculates and displays the measurement result in the specified units.

Digital Section

The Digital Section provides control over all of the Power Meter's functions. The following text describes the function of each of the components of the Digital Section.

The microprocessor controls the Power Meter by interpreting input instructions and issuing commands. Specific instructions for the microprocessor are stored in ROM. Data is exchanged between the microprocessor and the other blocks of the Digital Section over the data bus (D0-D7). The address bus (A0-A15) is used by the microprocessor to select either specific data from the RAM or instructions from the ROM and to provide address and control information inputs to the address and control decoder.

Note



The RAM contains the frequency vs. calibration factor (sensor data) tables. This data is protected by a battery (A3BT1). This battery occasionally needs replacement. For replacement indications and procedure, see "Battery Replacement Procedure" in the Digital Board Check further on in this section.

The address and control decoder interprets data from the microprocessor to create control signals that enable other components of the Digital Section to gain access to the data bus.

The system clock generator supplies timing signals to various components in the Digital Section. Two 2.0 MHz timing signals are sent to the microprocessor, and one 2.0 MHz timing signal is sent to the address and control decoder, the analog PIA, the analog timer, the keyboard and display PIA, the LED data latch, and the HP-IB interface. An 8.0 MHz signal from the system clock generator is sent to the analog timer and the display/keyboard controller.

The ROM contains permanent instructions that are interpreted and executed by the microprocessor. The RAM is used by the microprocessor to store various data such as front panel conditions and the Sensor Data tables. A battery supplies power to the RAM when the Power Meter is not connected to the mains power line. This prevents loss of stored data.

When the Power Meter is turned on, the reset circuitry holds the microprocessor in the reset state for 25 milliseconds to allow the power supply to reach a steady +5V. If the +5V power supply drops below +4.5V the reset circuitry will issue a signal to halt the microprocessor.

The analog PIA is an input/output device that allows the microprocessor to control the components in the Analog Section. Data from the data bus is transferred by the analog PIA to the Analog Section. This data is sent to the Analog Section via eleven data lines and two control lines (STRAMP and NADS).

The service test buffer is a digital multiplexer. Data lines AA0-AA2, STRAMP, NADS, and NWR control the multiplexer and select one of 8 data lines AD0-AD7 from the analog PIA. During self-test, the service test buffer verifies the data and control lines from the Digital Section to the Analog Section.

The analog timer measures the width of the pulse at the output of the analog-to-digital converter (in the Analog Section) and converts it to data that can be interpreted by the microprocessor as a measurement. The analog timer also generates a microprocessor interrupt signal. This interrupt signal occurs every 5 milliseconds.

The keyboard and display PIA provides the interface between the microprocessor and the display/keyboard controller. Data from the data bus is read by the PIA and sent to the display/keyboard controller. Keystroke information from the display/keyboard controller is read by the PIA. The PIA places the data on the data bus where it is read by the microprocessor.

The display/keyboard controller is an 8-bit microprocessor. The controller detects keystroke information from the keyboard, converts it to parallel data and transmits it to the microprocessor through the PIA. The microprocessor sends display data through the PIA to the controller. The controller then sends the data to the display.

The service function switch consists of seven single-pole single-throw switches. These switches allow the user to set seven of the eight data lines on the data bus to ground. Certain settings of these switches cause the microprocessor to invoke certain self tests. The service function switch is also used to set a default HP-IB address.

The LED data latch is used to convey operating information of the Power Meter. Data from the data bus causes the LEDs to illuminate or blink in certain patterns. These patterns convey information about errors and operating states. More information about the LED data latch and service function switch can be found in the troubleshooting information in this section.

The HP-IB interface is a bi-directional device that allows the Power Meter to interface with external instruments and controllers. Control signals and data from the data bus are received by the HP-IB interface and transmitted onto the external HP-IB bus through two devices: the HP-IB transmit/receive buffer and the HP-IB data control. Similarly, control signals and data from external instruments and controllers are received by the HP-IB interface and transmitted onto the data bus.

Analog Section

The Analog Section measures the input signal from the power sensor. The signal is amplified, filtered, and then measured. The Analog Section then produces a pulse with a width that is proportional to the power level of the measured signal. This pulse width is counted by the Digital Section. The microprocessor converts this count to a power measurement.

Power levels (from an external source) are converted to a DC voltage. A 220 Hz square wave signal from the power meter amplitude modulates the DC voltage. This creates a 220 Hz signal whose amplitude is proportional to the sensed power level. The 220 Hz amplitude modulated signal from the power sensor is fed into the input amplifier. The input amplifier contains a shaping network to compensate for non-linearities in ranges 4 and 5 of the power sensor.

Range attenuator 1 and range attenuator 2 work together to create five 10 dB power ranges whose values are determined by the power sensor being used. The higher the power at the input, the more it is attenuated. This creates greater sensitivity for low power measurements while providing the needed resolution for each range.

The variable gain amplifier provides between 23 and 39 dB of gain depending on the control signals from the Digital Section. The gain of the variable gain amplifier is digitally adjusted when the power sensor is calibrated to a reference power (the CAL function).

The bandpass amplifier provides filtering and amplification of the signal from range attenuator 2. The passband frequency is 220 Hz \pm 20 Hz with a gain of approximately 45 dB.

The synchronous phase detector has an alternating gain of +1 and -1 which is synchronized with the 220 Hz multivibrator. This alternating gain provides full-wave rectification of the 220 Hz signal from the 220 Hz bandpass amplifier.

The rectified 220 Hz signal from the synchronous phase detector is fed into the low pass filters. The low pass filters section consists of a fast filter and a slow filter. The fast filter has a response time of 45 milliseconds, while the slow filter has a response time of 800 milliseconds. When the digital filter is set to 1, 2, 4, or 8 averages, the fast filter is selected. When the digital filter is set to 16, 32, 64, 128, 256, or 512 averages, the slow filter is selected.

The internal digital filter is not a hardware component. It is a software routine that averages together readings from the low pass filters. This averaging produces a more stable and accurate power reading. The number of readings averaged together by the digital filter can be selected automatically or manually.

In auto filter mode, the Power Meter automatically sets the number of readings averaged together to satisfy the filtering requirements for most power measurements. The number of readings averaged together depends upon the resolution and the power range in which the Power Meter is currently operating. The following table lists the number of readings averaged for each range and resolution when the Power Meter is in auto filter mode.

**Table 8-3. Number of Averages vs. Range and Resolution
(Auto Filter Mode)**

	Res 1	Res 2	Res 3
	Number of Averages	Number of Averages	Number of Averages
Range 1	8	128	128
Range 2	1	8	256
Range 3	1	2	32
Range 4	1	1	16
Range 5	1	1	8

The output of the low pass filters is a dc voltage that is proportional to the power of the input signal. The output of the low pass filters is fed into the A-to-D input multiplexer.

The A-to-D input multiplexer can select any one of the following signals as the input to the analog-to-digital converter:

1. The low pass filter output.
2. The front or rear sensor resistor.
3. The B-GND (0V).
4. The +2.5V reference voltage (only selected during the CAL routine).
6. The RECORDER output (only selected during the CAL routine).
7. The Offset DAC output (only selected during the ZERO and CAL routines).

During the normal measurement cycle, the A-to-D input multiplexer selects the inputs in the following pattern:

1. B-GND.
2. Front sensor resistor.
3. Rear sensor resistor.
4. Low pass filter output.

The B-GND is selected for a reference for power measurement. The front and rear sensor resistors are checked to determine what sensor is attached and if the sensor has been changed since the last measurement. The low pass filter output is then selected to be sent to the A-to-D converter for measurement.

The analog-to-digital converter consists of three parts: a ramp generator, a comparator, and a counter (the analog timer circuit). The ramp generator produces a voltage that ramps from -0.78V to $+10.0\text{V}$. Upon receiving the STRAMP signal from the Digital Section, the ramp voltage begins ramping up. The comparator compares the low pass filter output from the A-to-D input multiplexer to the ramp voltage. When the ramp voltage matches the voltage from the low pass filters, the comparator issues the RAMPEND signal. The analog timer measures the time between the STRAMP and RAMPEND signals. The measured time is used by the Digital Section to determine the power level at the input power sensor.

The recorder output circuitry scales the signal from the output of the low pass filters to a voltage between 0V and $+1.0\text{V}$ that is proportional to the power input at the power sensor. This voltage is sent to the RECORDER OUTPUT connector on the back panel of the Power Meter. The RECORDER OUTPUT voltage range is from 0V to $+1\text{V}$ for each power range. This voltage is not corrected for the calibration factor. The RECORDER OUTPUT voltage is set to 1.00V during calibration.

The 220 Hz multivibrator provides the 220 Hz square wave drive signals to the power sensor and the synchronous phase detector. These signals are 180° out of phase with each other. This ensures that the output of the synchronous phase detector is a full-wave rectified voltage.

The 50 MHz Reference Oscillator provides a 50.0 ± 0.5 MHz output at $1.0 \text{ mW} \pm 0.7\%$. This output is used during operation to calibrate the individual power sensors used with the Power Meter. The output is provided at the POWER REF connector on the front panel or the rear panel (Option 003 only).

Power Supply

The Power Supply provides three regulated voltages plus a fourth regulated standby voltage. The three regulated voltages are $+15\text{V}$, -15V , and $+5\text{V}$. These voltages are used throughout the instrument. When the LINE switch is set to STBY, these voltages are switched off.

The standby voltage is a regulated $+5\text{V}$. This voltage is connected to the RAM components in the digital section. The standby voltage remains on constantly, even when the LINE switch is set to STBY. This prevents data loss when the Power Meter is in STBY mode. The standby voltage will switch off when the line (mains) voltage is disconnected from the Power Meter. A backup battery is installed in the Digital Section to prevent data loss when the line (mains) voltage is disconnected.

Troubleshooting

Test Equipment

Digitizing Oscilloscope	HP 54201A
Probe	HP 10081A
Sensor Cable	HP 11730A
Range Calibrator	HP 11683A
Digital Voltmeter (DVM)	HP 3456A
TTL/CMOS Logic Probe	HP 545A

Introduction

Note



This troubleshooting procedure assumes that the Installation Checklist (Paragraph 2-4 in Section 2, Installation) has been performed and that the proper line voltage and fuse have been selected.

The troubleshooting checks in this section are designed to isolate a malfunction to a schematic diagram as quickly as possible. The tests progress from general "over-all" tests to specific tests of certain areas of the Power Meter.

The HP 437B Power Meter consists of 4 major sections: the digital board, the analog board, the keyboard/display section, and the power supply.

The digital board consists of the digital circuitry of the Power Meter and the power supply. The digital board is located underneath the Power Meter's top cover. The analog board is located underneath the Power Meter's bottom cover.

The troubleshooting procedure is separated into three checks as follows:

1. Power Supply Check
2. Digital Board Check
3. Analog Board Check

Some malfunctions of the Power Meter may cause the display to fail. To aid troubleshooting when this situation occurs, the digital board has a set of service LEDs (D0 to D7). These LEDs blink in certain patterns to indicate various states and conditions of the Power Meter. These LEDs will be referred to in several places in this procedure.

Troubleshooting hints

The following items are general troubleshooting techniques that are useful when troubleshooting the Power Meter.

1. Check all ribbon cables, wires, and coaxial cables to ensure a tight connection.
2. Any cables that look worn or frayed should be checked for repeatable continuity. If continuity is not repeatable, the cable should be replaced.
3. A wrench should always be used when tightening or loosening coaxial connectors.
4. Any connectors that are disconnected should be inspected for damage.
5. Test equipment and personnel should be grounded to avoid static-induced failures. Observe all electrostatic discharge (ESD) precautions.

Cover Removal

1. Remove the four rear panel standoffs.
2. Remove the four feet on the bottom cover.
3. Remove the four screws from the bottom cover.
4. Carefully separate the top and bottom covers.

Power Supply Check

1. Connect the negative lead of the DVM to J3 pin 8 (DGND) on the digital board.
2. Measure the voltage at J3 pin 7. The voltage should read +5.0V, $\pm 0.25V$.
3. Measure the voltage at J3 pin 6. The voltage should read -15.0V, $\pm 0.5V$.
Record the voltage here.

-15.0V -15.002V

4. Measure the voltage at J3 pin 5. The voltage should read +15.0V, $\pm 0.5V$.
Record the voltage here.

+15.0V 14.991

- Calculate the difference between the absolute values of the -15.0V and +15.0V power supplies. The difference must be no greater than $\pm 2.00\%$ (-300 mV to +300 mV).

$$\begin{array}{r} 5.0384 \\ - 15.128 \\ \hline +15.181 \\ \hline .05341V \end{array}$$

$$\begin{array}{r} 15.062 \text{ (Absolute value of -15.0V)} \\ - 14.991 \text{ (Absolute value of +15.0V)} \\ \hline .071V \text{ (-300mV < calculated value < +300mV)} \\ 11.2V \end{array}$$

- If any of the voltages do not meet the specification, go to Service Sheet A3d to troubleshoot the power supply.
- Disconnect the DVM from the Power Meter.
- Set the oscilloscope as follows:
 - Vertical Sensitivity 10 mV/div
 - Sweep 5 ms/div S/div
 - Triggering internal
 - Coupling AC
- Connect the ground lead of the oscilloscope to J3 pin 8 (DGND).
- Connect the oscilloscope probe to J3 pin 7 (+5 REG) and observe the waveform. Ripple on the power supply should be less than ± 5 mV.
- Repeat steps 9 and 10 for J3 pin 6 (-15 REG) and J3 pin 5 (+15 REG).
- If the amount of ripple on the power supply is not within the specification, go to Service Sheet A3d to troubleshoot the power supply.

Digital Board Check

When the LINE switch is set to ON, the Digital Board runs a series of self tests to check for possible failures. If the Digital and Analog boards pass the self tests, the display will read "SELF TEST OK". If the Digital or Analog boards do not pass one of the self tests, the front panel will display one or more error codes. In case the display is inoperative, the service LEDs will indicate the error code by (a) blinking LED 1 rapidly, and (b) displaying the error code of the failed test on LEDs 2 through 8.

To invoke the self-tests (and set the meter to display all errors):

- Set the LINE switch to STBY.
- Set the switches in A3S4 to the following positions:

S7 = ON	ON
S6 = OFF	ON
S5 = OFF	OFF
S4 = ON	ON
S3 = OFF	OFF
S2 = OFF	OFF
S1 = OFF	OFF

3. Set the LINE switch to ON.
4. Observe the Power Meter's display. Note all of the error codes displayed. If the display is inoperative, note the patterns displayed on the service LEDs on the Digital board while LED 1 is blinking.
5. If the Power Meter displays a single error code, locate the error code in Table 8-5. If the Power Meter displays multiple error codes, locate the pattern of error codes displayed in Table 8-6. After locating the error codes, read the troubleshooting suggestions listed.
6. If using the service LEDs, locate the LED pattern in Table 8-4, "Service LED Error Codes". Read across to the "Error Code" column. Then locate the error code and the troubleshooting suggestions in Tables 8-5 or 8-6.



These tables contain the most common causes of the displayed error messages. Other malfunctions that are not listed may cause the error codes as well.

Table 8-4. Service LED Error Codes

LED Number							Error Code
2	3	4	5	6	7	8	
		(1 = on)					
0	1	1	1	1	0	1	61
0	1	1	1	1	1	0	62
1	0	0	0	0	0	0	64
1	0	0	0	0	0	1	65
1	0	0	0	0	1	0	66
1	0	0	0	0	1	1	67
1	0	0	0	1	0	0	68
1	0	0	0	1	0	1	69
1	0	0	0	1	1	0	70
1	0	0	0	1	1	1	71
1	0	0	1	0	0	0	72
1	0	0	1	0	0	1	73
1	0	0	1	0	1	0	74
1	0	0	1	0	1	1	75
0	0	0	1	0	1	0	0

Table 8-5. Single Error Codes and Troubleshooting Suggestions

Error Code	Troubleshooting Suggestions
61 only	<p>Stack RAM failure (A3U9). Check for TTL signals at A3U9 pins 20, 22, 27. If TTL signals are present, replace A3U9.</p> <p>If a TTL signal is not present at A3U9 pin 20, connect a logic probe to A3U12 pin 10. Set the Power Meter's LINE switch to STBY, then ON. A high-low-high transition should be detected at A3U12 pin 10. If not, replace A3U12.</p>
62 only	<p>ROM checksum failure (A3U8). Replace A3U8.</p>
64 only	<p>RAM failure (A3U9). Replace A3U9.</p>
65 only	<p>Analog I/O PIA Failure (A3U24). Replace A3U24.</p>
66 only	<p>Keyboard and Display PIA Failure (A3U25). Verify TTL signals at A3U22 pins 21 and 22. If signals are present, replace A3U25.</p>
67 only	<p>Analog-to-Digital converter failure. Verify TTL signals at the following locations on Service Sheet A3b: A3U12 pin 11, 13. A3U14 pins 7, 10, 11. A3U18 pins 13, 26. A3U24 pins 5 - 8, 40. If the TTL signals are present, troubleshoot circuit block Q on Service Sheet A4c and circuit blocks L, M, and N on Service Sheet A4b.</p>
68 only	<p>HP-IB failure (A3U4). Verify a TTL signal at A3U12 pin 12. If present, replace A3U4.</p>
69 only	<p>Timer failure (A3U18). Verify TTL signals at A3U16 pin 3, A3U22 pins 16, and A3U18 pin 3. If present, replace A3U18 or A3U21.</p> <p>Verify TTL signals at A3U18 pin 3, then check for a TTL low at A3U21B pin 9. If A3U21B pin 9 is not low, replace A3U21.</p> <p>If a TTL signal is present at A3U18 pin 3 and A3U21B pin 9 is at TTL low, check for TTL signals at A3U22 pin 16. If TTL signals are not present at A3U22 pin 16, replace A3U22.</p>

Table 8-5. Single Error Codes and Troubleshooting Suggestions (Cont.)

Error Code	Troubleshooting Suggestions
70 only	<p>Keyboard/Display controller failure (A3U25 or A3U26). Verify TTL signals at A3U25 pins 19 and 39. If not present, replace A3U25. If present, verify a TTL signal at A3U26 pin 15. If not present, replace A3U26.</p>
71 only	<p>Keyboard data failure (A3U25 or A3U26). Check for a pulse at A3U26 pin 8 when pressing a key. If a pulse is not present, press all keys consecutively while checking for a pulse. If none of the keys pressed creates a pulse at A3U26 pin 8, replace A3U26. If error 71 persists, replace A3U25.</p>
72 only	<p>Data line to A3U26 is open. Check data bus from A3U25 to A3U26 (KD0-KD7) or replace the Digital board.</p>
73 only	<p>Keyboard/Display controller self-test failure (A3U26). Replace A3U26.</p>
74 only	<p>Display not responding. Ensure display cable (at A3J8) is connected. Verify TTL signals at A3U26 pins 13, 14. If the display cable is connected and TTL signals are present, replace the display.</p>
75 only	<p>Digital failure at A3J6. Disconnect ribbon cable W6 at A3J6. Set LINE switch to STBY, then ON. If error code 75 persists, replace A3U24 (and A3U28 if necessary).</p> <p>If the error code is not repeated, the problem is on the Analog board. One of the Analog board components connected to the following data lines is preventing normal operation.</p> <p>AD0 - AD7 AA0 - AA2 NADS STRAMP</p> <p>Turn to Service Sheets A4a, b, or c to troubleshoot the Analog board.</p>

Note



The following table lists troubleshooting suggestions for patterns of multiple displayed error codes. To find the right troubleshooting suggestion, locate the error code pattern that is in the exact sequence displayed on the Power Meter's front panel.

Some combinations of error codes may occur which are not in this table. To help identify the cause of the problem, locate common data and control lines among the components indicated by the error codes.

Table 8-6. Multiple Error Codes and Troubleshooting Suggestions

Error Code	Troubleshooting Suggestions
65, 67	Verify TTL signals at A3U24 pins 21, 23, and 36. If TTL signals are present, replace A3U24.
65, 75, 67	Verify TTL signals at A3U24 pin 35. If TTL signals are present, replace A3U24.
65, 71, 68, 75, 67	Verify TTL signals at A3U12 pin 11. If TTL signals are present, replace A3U12.
65, 70, 68, 69, 75, 67	Verify TTL signals at A3U20 pin 5. If TTL signals are present, replace A3U20.
66, 70	Verify TTL signals at A3U25 pin 23. If TTL signals are present, replace A3U25.
66, 68, 69, 75, 67	Verify TTL signals at A3U20 pin 7. If TTL signals are present, replace A3U20.
66, 65, 70, 68, 75, 67	Verify TTL signals at A3U20 pin 3 and A3U12 pin 15. If TTL signals are present, replace A3U12.
66, 65, 70, 75, 67	Verify TTL signals at A3U20 pin 5. If TTL signals are present, replace A3U20.

Table 8-6. Multiple Error Codes and Troubleshooting Suggestions (Cont.)

Error Code	Troubleshooting Suggestions
66, 65, 70, 68, 69	Verify TTL signals at A3U12 pin 13. If TTL signals are present, replace A3U12. See the note following in this table.
66, 65, 70, 69, 67	Verify TTL signals at A3U20 pin 7. If TTL signals are present, replace A3U20. See the note following in this table.
66, 65, 70, 68, 69, 75, 67	<p>Verify TTL signals at A3U6 pin 2. If TTL signals are present, replace A3U6. See the note following in this table.</p> <p>Note - A malfunction in any of the following components will cause the previous three error code combinations: A3U4, A3U6, A3U18, A3U24, A3U25, and A3U27.</p>
67, 65, 73, 69, 75	Verify TTL signals at A3U6 pin 4. If TTL signals are present, replace A3U6.
68, 69, 67	Verify TTL signals at A3U20 pin 9. If TTL signals are present, replace A3U20.
69, 67	Verify TTL signals at A3U18 pin 15. If TTL signals are not present, replace A3U12. If TTL signals are present, replace A3U18.
70, 67	Verify TTL signals at A3U12 pin 12. If TTL signals are not present, replace A3U12. If TTL signals are present, replace A3U4.
70, 68	Verify TTL signals at A3U19 pin 4. If TTL signals are not present, replace A3U19. If TTL signals are present, replace A3U4 and A3U26.
75, 67	Verify TTL signals at A3U24 pin 39. If TTL signals are present replace A3U24.

Battery Replacement Procedure

Note 

Battery replacement is necessary when the Power Meter repeatedly displays "RECALL FAIL" when turned on.

1. Set the LINE switch to STBY.
2. Leave the line (Mains) power cord connected.
3. Remove A3BT1 from the Digital Board.
4. Replace A3BT1 with the recommended battery, HP part number 1420-0341.

Analog Board Check

This section contains procedures for troubleshooting the Analog board. Most of the procedures will narrow the cause of a malfunction to a schematic. Some of the procedures will isolate the problem to a circuit or component.

Note 

The following procedures must be performed in the sequence presented.

Analog Board Functional Verification

1. Connect the equipment as shown in Figure 8-1.

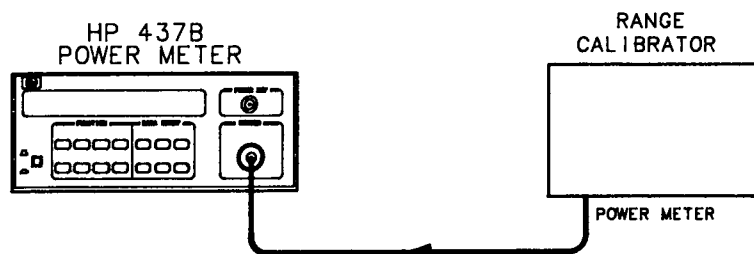



Figure 8-1. Analog Board Troubleshooting Setup

- Set the range calibrator as follows:

FUNCTIONSTANDBY
RANGE 1 mW

- Press the PRESET/LOCAL key, then the ENTER key.
- Press the ZERO key on the Power Meter. The Power Meter should perform the zeroing function. If the Power Meter will not zero, proceed to the Analog Board Troubleshooting Procedure.
- Set the FUNCTION switch on the range calibrator to CALIBRATE.
- Press the Power Meter's dBm/W key for a reading in watts.
- Press the CAL key on the Power Meter.
- Press  or  until the display reads "REF CF 100.0%".
- Press the Power Meter's ENTER key. The Power Meter should perform the calibration function. Verify that the Power Meter display reads 1.00 ± 0.001 mW.
- If the Power Meter will not calibrate, proceed to the Analog Board Troubleshooting Procedure.
- Set the range calibrator's RANGE switch to the positions shown in the following table. For each setting, verify that the Power Meter's reading is within the limits shown.

Note



If the readings are not within limits when the range calibrator is set to 10 mW or 100 mW, ranges 4 and 5 may need adjustment. Perform Adjustment 5-4, Ranges 4 and 5 Shaper Adjustment, in Section 5 of this service manual and then retest the Power Meter at 10 mW and 100 mW.

Range Calibrator Setting	Min	Actual Results	Max
10 μ W	9.90 μ W	_____	10.10 μ W
100 μ W	99.5 μ W	_____	100.5 μ W
1 mW	0.995 mW	_____	1.005 mW
10 mW	9.95 mW	_____	10.05 mW
100 mW	99.5 mW	_____	100.5 mW

If the Power Meter does not meet these limits, a problem may exist with A4U5, A4U7, or A4R16, 17, 24, 25, or 26. Replace these components. If

replacing the components doesn't solve the problem, replace the Analog board.

12. Set the range calibrator's RANGE switch to 1 mW.
13. Press the Power Meter's CAL key. Enter a REF CF of 100.0%.
14. Connect the DVM to the RECORDER OUTPUT connector on the rear panel.
15. Verify that the DVM reading is 1.000V \pm 0.003 Vdc.
16. If the voltage is correct, go to Step 18. If the voltage is incorrect, continue with the next step.
17. Using the logic probe, verify the presence of TTL signals at A4U18 pins 12 and 13 (on Service Sheet A4c). If the signals are present, turn to Service Sheet A4c to troubleshoot the Recorder Output circuit block.
18. Press the Power Meter's PWR REF (SHIFTed ) key.
19. Set the oscilloscope as follows:

Vertical Sensitivity	100 mV/div
Sweep	5 ns/div
Triggering	Internal
Coupling	DC, 50 Ω
20. Connect the oscilloscope to the POWER REF output connector on the Power Meter's front panel.
21. Verify the 50 MHz signal as shown in Figure 8-2.

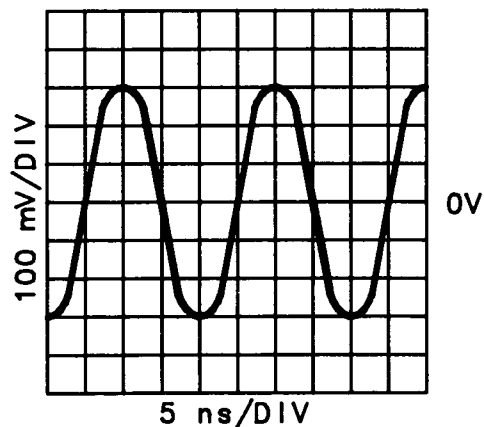

Figure 8-2. 50 MHz POWER REF Waveform

22. If the 50 MHz signal can be verified, the Power Meter is fully operational. No further troubleshooting is necessary. If the 50 MHz signal cannot be verified, proceed to Step 23.

23. Using the logic probe or oscilloscope, check for a logical high (>+2.5V) at A4U16, pin 19 (on Service Sheet A4c).
24. If the signal at A4U16 pin 19 is a logical high, turn to Service Sheet A4c and troubleshoot either the 50 MHz Reference Oscillator or the Power Reference Switch.
25. If the signal at A4U16 pin 19 is not a logical high, turn to Service Sheet A4c and troubleshoot the Microprocessor Control circuit or the ribbon cable assembly W6.

Analog Board Troubleshooting

Microprocessor Control Circuit Verification.

1. Press the Power Meter's PRESET/LOCAL key.
2. Connect the range calibrator to the Power Meter's SENSOR connector.

Note



For steps 3 through 12, refer to Figure 8-3.

3. Using a logic probe, verify the presence of TTL signals at A4U16 pins 3, 4, 7, 8, 12-18 and A4U18 pins 7, 9-13.
4. Set the Power Meter's POWER REF to off.
5. Verify a logical low level (<.80V) at U16, pin 19 (CALOSC).
6. Press the Power Meter's SET RANGE key. Select range 3.
7. Verify a logical high level at A4U16 pin 6 (NATTEN).
8. Press the Power Meter's SET RANGE key. Select range 4.
9. Verify a logical low level at A4U16 pin 6.
10. Verify a logical high level at A4U16 pin 2 (NSLOW) and a logical low level at A4U16 pin 5 (NFAST).
11. Press the SET RANGE key. Select range 1.
12. Verify a logical low level at A4U16 pin 2 (NSLOW) and a logical high level at A4U16 pin 5 (NFAST).

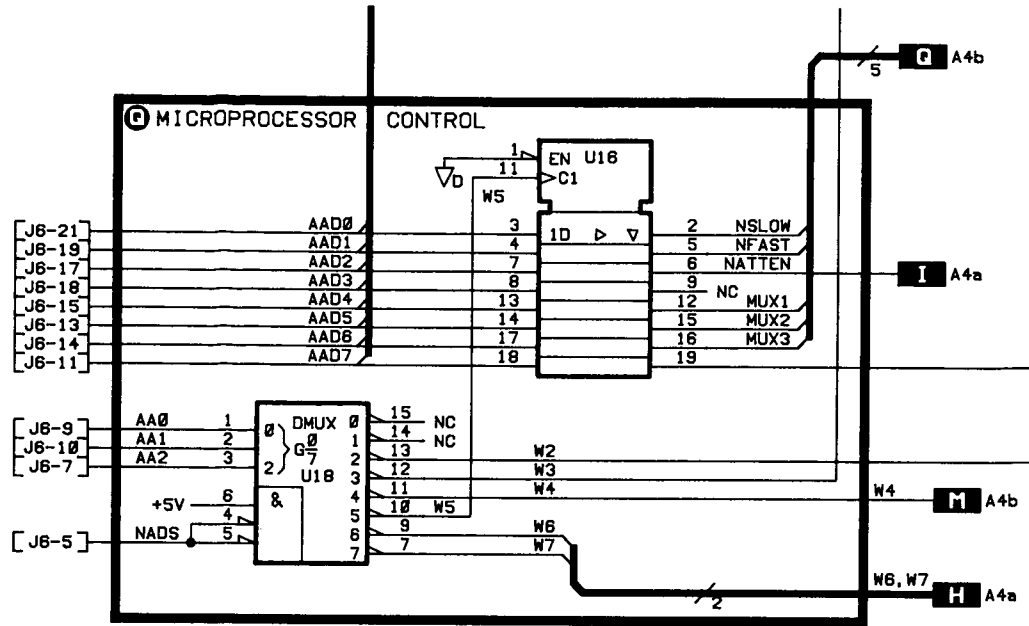

Figure 8-3. A4U16, U18 Pinout Diagram

The digital control signals for the Analog board have now been verified. Continue with the troubleshooting procedure for Service Sheet A4a.

Service Sheet A4a troubleshooting

1. Press the Power Meter's SET RANGE key. Select range 3.
2. Press the dBm/W key for a reading in watts.
3. Set the range calibrator as follows:

FUNCTIONCALIBRATE
RANGE1 mW

4. Verify that the level at A4TP10 (C-GND) is equal to A4TP9 (A-GND) ± 5.00 mV.
5. Set the oscilloscope as follows:

Vertical Sensitivity 5V/div
Sweep 1 ms/div
Coupling DC
Triggering Internal

6. Connect the oscilloscope to A4TP3 (220 Hz). Verify the signal shown in Figure 8-4.

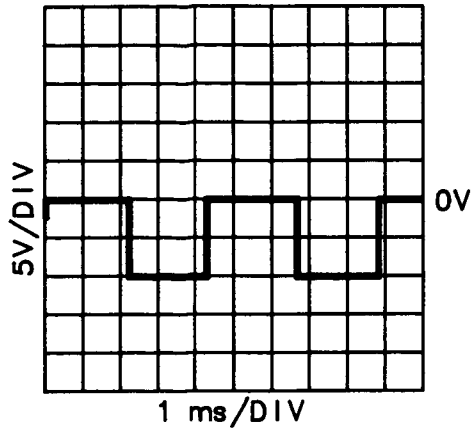

Figure 8-4. A4TP3, 220 Hz Multivibrator Waveform

7. Set the oscilloscope as follows:

Vertical Sensitivity 50 mV/div
Sweep 1 ms/div
Triggering External
Coupling AC

Connect the oscilloscope's external trigger input to A4TP3 (220 Hz).

8. Connect the oscilloscope to A4U7 pin 3. Verify the signal shown in Figure 8-5. The signal level should be 0.12 V_{p-p} ± 0.01V.

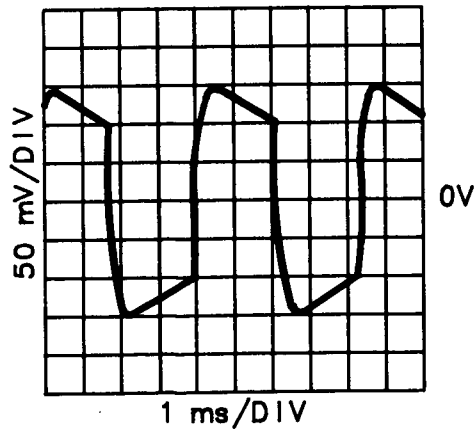

Figure 8-5. A4U7 pin 3 Range Attenuator 1 Waveform

9. Change the oscilloscope's vertical sensitivity setting to 1V/div.
10. Connect the oscilloscope to A4TP17. Verify the signal shown in Figure 8-6. The signal level should be between 2.00 and 11.00 V_{p-p}.

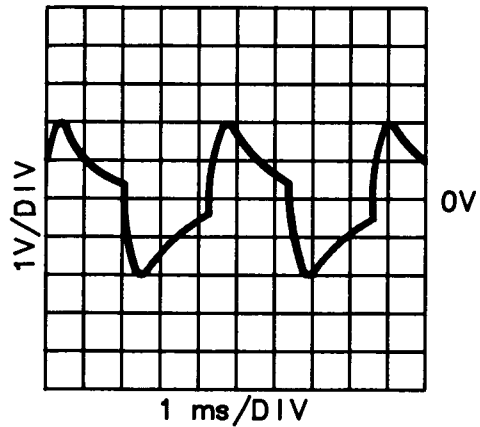

Figure 8-6. A4TP17 Variable Gain Amplifier Waveform

11. Connect the oscilloscope to A4TP4. Verify the signal shown in Figure 8-7. The signal level should be 1.8 times the voltage at A4TP17 p-p, $\pm 0.8V$.

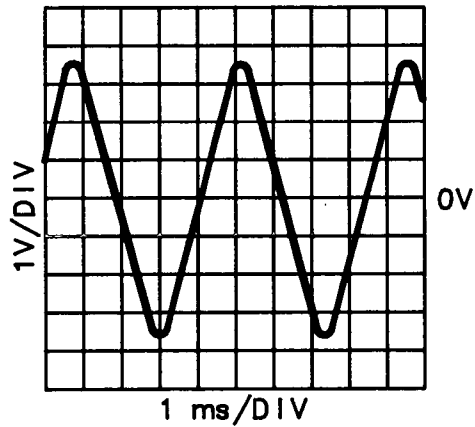

Figure 8-7. A4TP4 Bandpass Amplifier Waveform

12. Connect the oscilloscope to A4TP5. Verify the signal shown in Figure 8-8. The signal level should be .9 times the voltage at A4TP17 p-p, $\pm 0.4V$. Retain the peak voltage reading for steps 13 and 15.

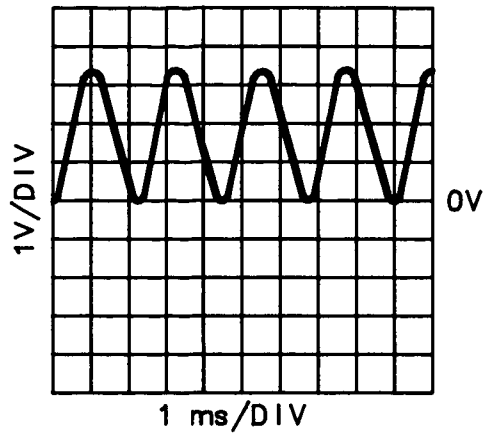

Figure 8-8. A4TP5 Phase Detector Waveform

Service Sheet A4b Troubleshooting

13. Select a digital filter setting of 1 for the Power Meter. This selects the fast low-pass filter.
14. Connect the oscilloscope to A4TP7.
15. Verify that the dc voltage at A4TP7 is approximately equal to the peak voltage at A4TP5 (see Step 9).
16. Select a digital filter setting of 512 for the Power Meter. This selects the slow low-pass filter.
17. Verify that the dc voltage at A4TP7 is approximately equal to the peak voltage at A4TP5 (see Step 10).
18. Verify that the dc voltage from the AUTO-ZERO DAC at the junction of R57 and C26 (see Figure 8-9) is between ± 15 mV.

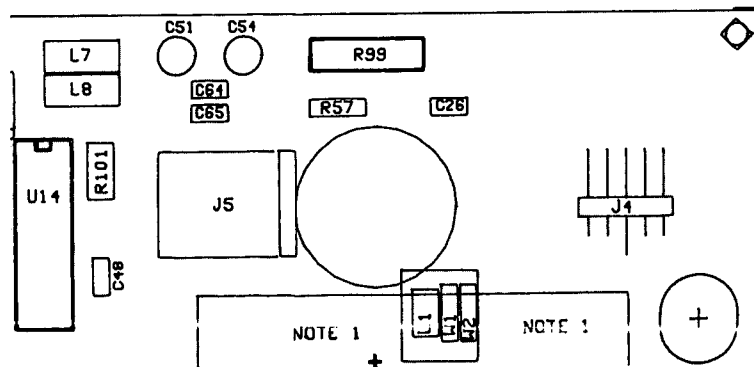

Figure 8-9. R57-C26 Junction Location

19. Set the oscilloscope as follows:

Vertical Sensitivity 1V/div
Sweep 10 ms/div
Coupling DC
Triggering External, $\div 1$

Connect the oscilloscope's external trigger input to A4U13 pin 16.

20. Connect the oscilloscope to A4TP18. Verify the signal shown in Figure 8-10.

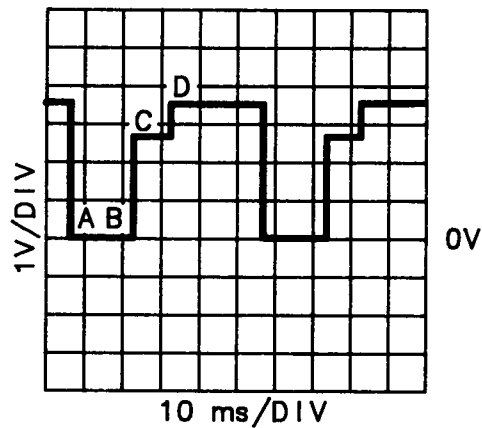

Figure 8-10. A4TP18 ADC Input Waveform

21. Connect the oscilloscope to A4TP13. Verify the signal shown in Figure 8-11.

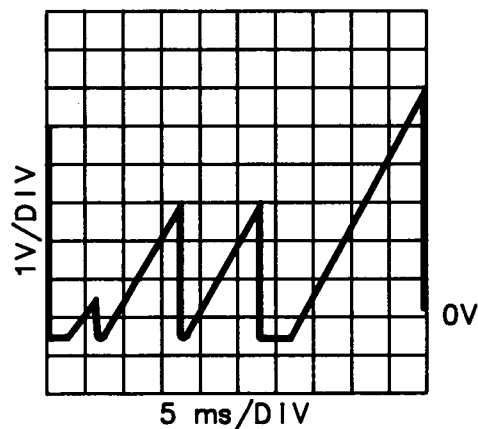

Figure 8-11. A4TP13 ADC Ramp Waveform

22. Connect the oscilloscope to A4TP14. Verify the signal shown in Figure 8-12.

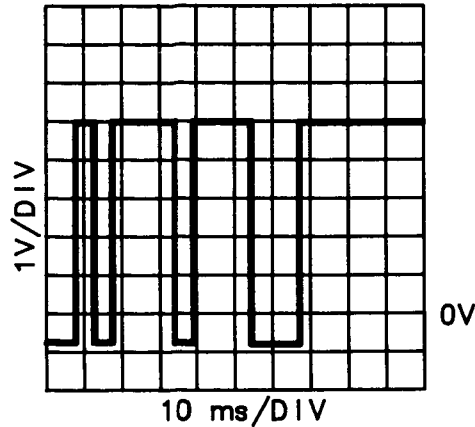

Figure 8-12. A4TP14 Ramp End Waveform

Service Sheet A4c Troubleshooting

23. Set the oscilloscope's vertical sensitivity to 5.0V/div.
24. Repeat Steps 12 through 16 of the Analog Board Functional Verification procedure (checking the RECORDER OUTPUT signal).
25. Repeat Steps 18 through 22 of the Analog Board Functional Verification procedure (checking the POWER REF signal).

Power Sensor Detection Circuitry Troubleshooting

Note



The following steps need to be performed only if the Power Meter indicates sensor problems. For example:

- a. The Power Meter displays "NO SENSOR" when a sensor is attached.
- b. The Power Meter does not display "NO SENSOR" when a sensor is not attached.
- c. The Power Meter displays "2 SENSOR ERR" when only one sensor or no sensor is attached (Option 002 or 003 only).
- d. The Power Meter is operating in the wrong power range for the attached sensor.

1. Connect the oscilloscope to A4TP18.

2. Refer to Figure 8-10, A4TP18. Examine the displayed waveform at point B (if the power sensor is connected to the front input port) or at point C (if the power sensor is connected to the rear input port).

The labels on Figure 8-10 indicate measurements by the ADC input multiplexer as follows:

- A: Measures the ground connection at B-GND.
- B: Measures the voltage level at the front sensor.
- C: Measures the voltage level at the rear sensor.
- D: Measures the output of the low-pass filters.

3. Using the table below, verify the proper voltage at A4TP18 points B or C for the power sensor you are using.

Table 8-7. Sensor Power Ranges, Resistor Values, and Voltages

Power Sensor	Power Range	Power Sensor Resistor Value	A4TP18 Voltage
8484A	-70 to -20 dBm (100 pW to 10 μ W)	10.0 k Ω	1.00V
8481A, 8482A, 8483A, 8485A, R8486A, Q8486A, Range Calibrator	-30 to +20 dBm 1 μ W to 100 mW	0 Ω (Gnd)	0.00V
8481H, 8482H	-10 to +35 dBm 100 μ W to 3 W	3.46 k Ω	0.47V
8481B, 8482B	0 to +44 dBm 1 mW to 25 W	6.19 k Ω	.073V

Completion of Testing

Upon completion of testing, place all switches in their original positions (see below), remove all test gear, and restore the Power Meter to the normal operating condition. If repairs have been made or adjustments changed, refer to the references listed in the front of this section. Then refer to the applicable sections for post-testing procedures.

The normal operating positions of the switches in A3S4 are:

S1 = 1

S2 = 1

S3 = 0

S4 = 1

S5 = 1

S6 = 1

S7 = 0